

# FIN

## FIN

### FLOOD LIGHT



LAST UPDATE: 18-03-2026



FIN is a series of floodlights with Symmetric and Bi-symmetric light distribution. Fin is equipped with High Power LED module available in 2700K, 3000K and 4000K with high CRI. It is also available in traditional HID light source. The aluminium reflectors and PC lenses used in this luminaire are designed by high-end lighting engineering software. The graduated scale provides precise aiming of the luminaire. The range of accessories such as ground mount spike, tree strap and glare shield cap makes FIN a dynamic floodlight choice. FIN is suitable to light up small to medium sized objects or areas such as signage boards, ceiling, building facades, etc.

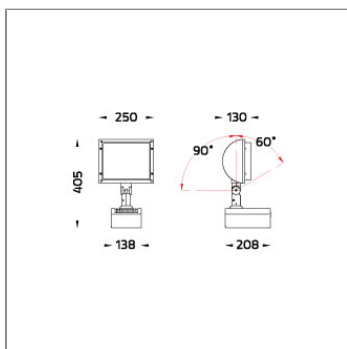

### Technical Data



|                       |                    |
|-----------------------|--------------------|
| Ordering Code :       | 2302-A-3-898-XX    |
| Lamp :                | LED                |
| Beam :                | 12°                |
| CCT :                 | 4000 K             |
| CRI :                 | CRI >80            |
| SDCM :                | SDCM = 3           |
| Lamp Lumen :          | 6180 lm            |
| Luminaire Lumen :     | 5330 lm            |
| Lamp Wattage :        | 49 W               |
| Luminaire Wattage :   | 57 W               |
| Efficacy :            | 93 lm/W            |
| Ambient Temperature : | 50°C               |
| Lumen Maintenance     | L70B10 >66,000 h   |
| Controller :          | On-Off             |
| Input Voltage :       | 220-240Vac 50/60Hz |
| Net Weight :          | 5.40 kg.           |

### Ordering code guide

XXXX-X-X-XXX-XX

- A Product Code
- B Reflector
- C Electrical Component
- D Lamp
- E Color

















Icon definition

\*Due to the constancy of product development, we reserve the right to alter all specification without prior notice.

Unilamp Co., Ltd.  
461 Ramintra Road, Kannayao, Bangkok 10230 Thailand  
Tel : +66(O)2 943 2420-1, +66(O)2 946 4170-1  
Fax : +66(O)2 943 2419  
online@unilamp.co.th  
www.unilamp.co.th

### Specification

|   |  |   |          |   |             |   |              |   |                    |   |          |
|---|--|---|----------|---|-------------|---|--------------|---|--------------------|---|----------|
| IEC Standard  | IEC 60598-1 General Requirement<br>IEC 60598-2-1 Fixed Luminaires  |   |          |   |             |   |              |   |                    |   |          |
| Protection  | IP65 Class I   |   |          |   |             |   |              |   |                    |   |          |
| IK Rating   | Protection against mechanical impact IK08 on body and IK07 optical part.   |   |          |   |             |   |              |   |                    |   |          |
| Luminaires Body Housing   | High-pressure die cast aluminum alloy body and components.   |   |          |   |             |   |              |   |                    |   |          |
| Coating Process   | Nano Ceramic surface conversion, resistant to corrosive environment. Luminaire primarily coated with epoxy resin and top coated with UV stabilized polyester powder and cured in digital temperature controlled chamber at 200°C.  |   |          |   |             |   |              |   |                    |   |          |
| Diffuser  | Impact resistant safety tempered glass cover. Able to withstand the temperature up to 250°C.   |   |          |   |             |   |              |   |                    |   |          |
| Lens  | Molded PC lens from renowned manufacturers in various light distribution patterns.   |   |          |   |             |   |              |   |                    |   |          |
| Adjustable Optic  | Adjustable aiming unit through graduated scale.  |   |          |   |             |   |              |   |                    |   |          |
| Gasket  | Post-cured treated silicone gasket. Temperature and weather resistant. Working temperature -40°C to +200°C.  |   |          |   |             |   |              |   |                    |   |          |
| External Screws   | External screws are in stainless steel with protection grease.   |   |          |   |             |   |              |   |                    |   |          |
| Cable Entry   | Cable entry protected by M20 cable gland. To be used with H05RN-F/ H07RN-F cable with 7-13mm. diameter.  |   |          |   |             |   |              |   |                    |   |          |
| Led   | High efficiency LED module utilized chips from world renowned manufacturer. Assembled on MCPCB and mounted on to heat conductive material.   |   |          |   |             |   |              |   |                    |   |          |
| Driver  | High quality constant current LED driver. Conform to safety standard and electromagnetic compatibility standard.   |   |          |   |             |   |              |   |                    |   |          |
| Enhanced Protection   | The luminaire is equipped with a 10kV surge protection device, the function of the protector is indicated by a LED, performance in compliance with IEC61643-11   |   |          |   |             |   |              |   |                    |   |          |
| Internal Wire   | Tinned copper conductor with silicone insulated internal wire. IMQ approved. Working temperature -40°C to +180°C.  |   |          |   |             |   |              |   |                    |   |          |
| Terminal Block  | Terminal block in GFR PA6.6 for cable with cross section up to 2.5 sqmm. VDE approved.<br>Class1 luminaire provided with the earth connection.   |   |          |   |             |   |              |   |                    |   |          |
| Caution   | Installation work has to be carried on according to the enclosed installation manual.  |   |          |   |             |   |              |   |                    |   |          |
| Color   | <table border="0"> <tr> <td></td> <td>Black O1</td> </tr> <tr> <td></td> <td>Graphite O2</td> </tr> <tr> <td></td> <td>Dark Grey O3</td> </tr> <tr> <td></td> <td>Aluminum Silver O4</td> </tr> <tr> <td></td> <td>White O6</td> </tr> </table> |  | Black O1 |  | Graphite O2 |  | Dark Grey O3 |  | Aluminum Silver O4 |  | White O6 |
|  | Black O1   |   |          |   |             |   |              |   |                    |   |          |
|  | Graphite O2  |   |          |   |             |   |              |   |                    |   |          |
|  | Dark Grey O3   |   |          |   |             |   |              |   |                    |   |          |
|  | Aluminum Silver O4   |   |          |   |             |   |              |   |                    |   |          |
|  | White O6   |   |          |   |             |   |              |   |                    |   |          |

### Light Distribution

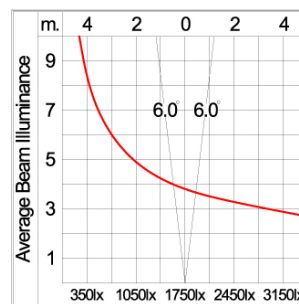
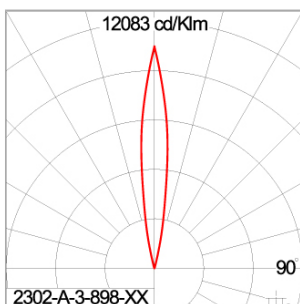

# FIN

## FIN

### FLOOD LIGHT



LAST UPDATE: 18-03-2026

#### Accessories

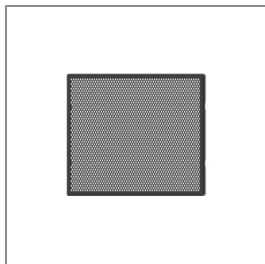

Ordering Code:  
AUN-GSH-0009-00  
Honeycomb louver, LED,  
pre-assembly from factory

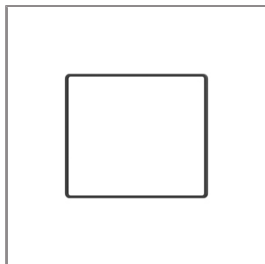

Ordering Code:  
AUN-SOF-0023-00  
Softening filter, LED,  
pre-assembly from factory



Ordering Code:  
AUN-CON-0009-00  
IP68 connection device,  
cable diameter 5-9.5mm,  
On-Off



Ordering Code:  
AUN-CON-0013-00  
IP68 connection device,  
cable diameter 7-11.5mm,  
On-Off



Ordering Code:  
AUN-CAB-0002-00  
Cable HO7RN-F 3x1sqmm,  
L= 2000, with UniBlock  
anti-humidity kit,  
pre-assembly from factory



Ordering Code:  
AUN-CLP-0004-XX  
Pole clamp, pole diameter  
102-105mm



Ordering Code:  
AUN-CAB-0004-00  
Cable HO7RN-F 3x1sqmm,  
L= 500, with UniBlock  
anti-humidity kit,  
pre-assembly from factory

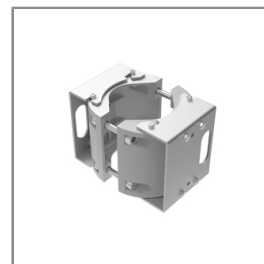

Ordering Code:  
AUN-CLP-0006-XX  
Pole clamp, pole diameter  
60-76mm

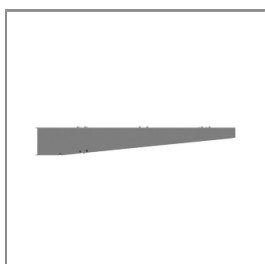

Ordering Code:  
AUN-MOT-0013-XX  
Pole mounting arm, for 1-3  
projector



Ordering Code:  
AUN-CLP-0008-XX  
Pole clamp, pole diameter  
102-105mm, for wall or  
pole mounting arm

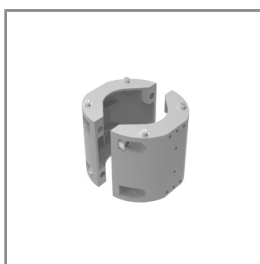

Ordering Code:  
AUN-CLP-0009-XX  
Pole clamp, pole diameter  
60-76mm, for wall or pole  
mounting arm

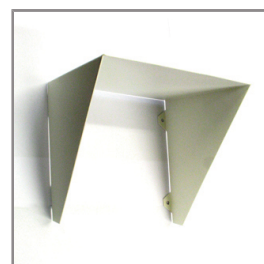

Ordering Code:  
AUN-GHS-0014-XX  
Glare shield cap

\*Due to the constancy of product development,  
we reserve the right to alter all specification  
without prior notice.

Unilamp Co., Ltd.  
461 Ramintra Road, Kannayao, Bangkok 10230 Thailand  
Tel : +66[0]2 943 2420-1, +66[0]2 946 4170-1  
Fax : +66[0]2 943 2419  
online@unilamp.co.th  
www.unilamp.co.th

# FIN

## FIN

### FLOOD LIGHT



LAST UPDATE: 18-03-2026



Ordering Code:  
AUN-ESP-0001-00  
Earth spike, GFR polymer



Ordering Code:  
AUN-TRS-0002-00  
Tree strap, big mounting  
base



Ordering Code:  
ALUMINUM-POLE-FOR-FIN  
Please contact Sales  
Representative



Ordering Code:  
STEEL-POLE-FOR-FIN  
Please contact Sales  
Representative

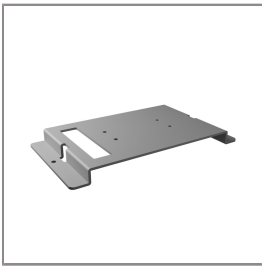

Ordering Code:  
AUN-BRK-0015-XX  
Mounting bracket,  
pre-assembly from factory

\*Due to the constancy of product development,  
we reserve the right to alter all specification  
without prior notice.

Unilamp Co., Ltd.  
461 Ramintra Road, Kannayao, Bangkok 10230 Thailand  
Tel : +66[0]2 943 2420-1, +66[0]2 946 4170-1  
Fax : +66[0]2 943 2419  
online@unilamp.co.th  
www.unilamp.co.th