

FIN

FIN LED FLOOD LIGHT



LAST UPDATE: 18-03-2026



FIN is a series of floodlights with Symmetric and Bi-symmetric light distribution. Fin is equipped with High Power LED module available in 2700K, 3000K and 4000K with high CRI. It is also available in traditional HID light source. The aluminium reflectors and PC lenses used in this luminaire are designed by high-end lighting engineering software. The graduated scale provides precise aiming of the luminaire. The range of accessories such as ground mount spike, tree strap and glare shield cap makes FIN a dynamic floodlight choice. FIN is suitable to light up small to medium sized objects or areas such as signage boards, ceiling, building facades, etc.

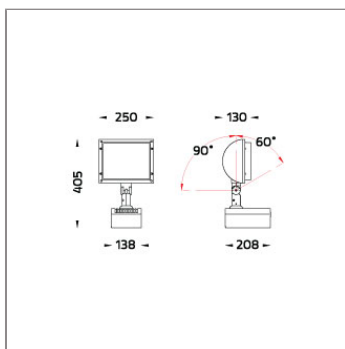

Technical Data



Ordering Code :	2302-7-4-907-XX
Lamp :	LED
Beam :	Bi-Symmetric
CCT :	4000 K
CRI :	CRI >80
SDCM :	SDCM = 3
Lamp Lumen :	6950 lm
Luminaire Lumen :	6110 lm
Lamp Wattage :	55 W
Luminaire Wattage :	60 W
Efficacy :	101 lm/W
Ambient Temperature :	50°C
Lumen Maintenance	L70B10 >66,000 h
Controller :	DIM 1-10V
Input Voltage :	220-240Vac 50/60Hz
Net Weight :	6.40 kg.

Ordering code guide

XXXX-X-X-XXX-XX
A C E

- A Product Code
- B Reflector
- C Electrical Component
- D Lamp
- E Color

















Icon definition

*Due to the constancy of product development, we reserve the right to alter all specification without prior notice.

Unilamp Co., Ltd.
461 Ramintra Road, Kannayao, Bangkok 10230 Thailand
Tel : +66(O)2 943 2420-1, +66(O)2 946 4170-1
Fax : +66(O)2 943 2419
online@unilamp.co.th
www.unilamp.co.th

Specification

IEC Standard	IEC 60598-1 General Requirement IEC 60598-2-1 Fixed Luminaires										
Protection	IP65 Class I										
IK Rating	Protection against mechanical impact IK08 on body and IK07 optical part.										
Luminaires Body Housing	High-pressure die cast aluminum alloy body and components.										
Coating Process	Nano Ceramic surface conversion, resistant to corrosive environment. Luminaire primarily coated with epoxy resin and top coated with UV stabilized polyester powder and cured in digital temperature controlled chamber at 200°C.										
Diffuser	Impact resistant safety tempered glass cover. Able to withstand the temperature up to 250°C.										
Reflector	High performance CNC forming aluminum reflector sheet.										
Adjustable Optic	Adjustable aiming unit through graduated scale.										
Gasket	Post-cured treated silicone gasket. Temperature and weather resistant. Working temperature -40°C to +200°C.										
External Screws	External screws are in stainless steel with protection grease.										
Cable Entry	Cable entry protected by M20 cable gland. To be used with H05RN-F/ H07RN-F cable with 7-13mm. diameter.										
Led	High efficiency LED module utilized chips from world renowned manufacturer. Assembled on MCPCB and mounted on to heat conductive material.										
Driver	High quality Dimmable Driver (1-10V) in constant current. Conform to applicable safety standards and electromagnetic compatibility.										
Enhanced Protection	The luminaire is equipped with a 10kV surge protection device, the function of the protector is indicated by a LED, performance in compliance with IEC61643-11										
Internal Wire	Tinned copper conductor with silicone insulated internal wire. IMQ approved. Working temperature -40°C to +180°C.										
Terminal Block	Terminal block in GFR PA6.6 for cable with cross section up to 2.5 sqmm. VDE approved. Class1 luminaire provided with the earth connection.										
Caution	Installation work has to be carried on according to the enclosed installation manual.										
Color	<table border="0"> <tr> <td></td> <td>Black O1</td> </tr> <tr> <td></td> <td>Graphite O2</td> </tr> <tr> <td></td> <td>Dark Grey O3</td> </tr> <tr> <td></td> <td>Aluminum Silver O4</td> </tr> <tr> <td></td> <td>White O6</td> </tr> </table>		Black O1		Graphite O2		Dark Grey O3		Aluminum Silver O4		White O6
	Black O1										
	Graphite O2										
	Dark Grey O3										
	Aluminum Silver O4										
	White O6										

Light Distribution

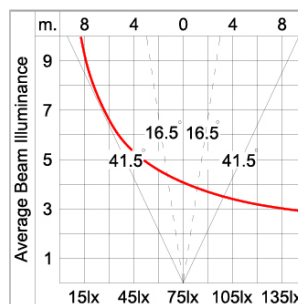
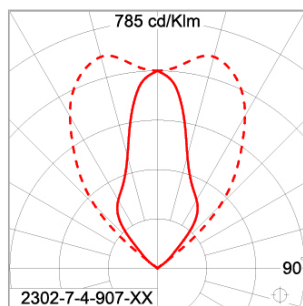

FIN

FIN LED FLOOD LIGHT



LAST UPDATE: 18-03-2026

Accessories



Ordering Code:
AUN-CON-0011-00
IP68 connection device,
cable diameter 7.1-13mm,
1-10V or DALI



Ordering Code:
AUN-CON-0014-00
IP68 connection device,
cable diameter 8-12.5mm,
1-10V or DALI



Ordering Code:
AUN-CLP-0004-XX
Pole clamp, pole diameter
102-105mm

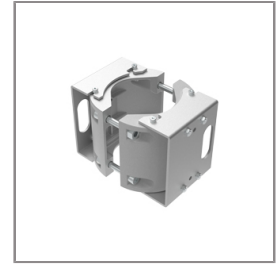

Ordering Code:
AUN-CLP-0006-XX
Pole clamp, pole diameter
60-76mm

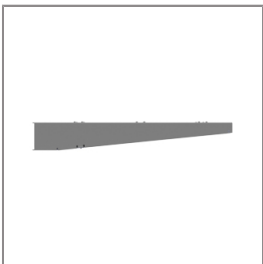

Ordering Code:
AUN-MOT-0013-XX
Pole mounting arm, for 1-3
projector

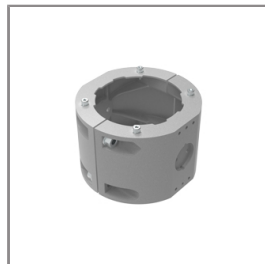

Ordering Code:
AUN-CLP-0008-XX
Pole clamp, pole diameter
102-105mm, for wall or
pole mounting arm

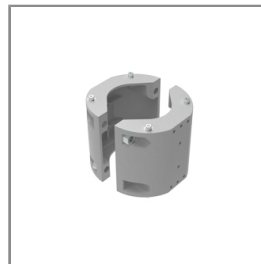

Ordering Code:
AUN-CLP-0009-XX
Pole clamp, pole diameter
60-76mm, for wall or pole
mounting arm

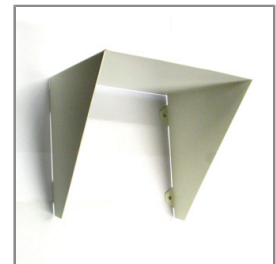

Ordering Code:
AUN-GHS-0014-XX
Glare shield cap



Ordering Code:
AUN-ESP-0001-00
Earth spike, GFR polymer



Ordering Code:
AUN-TRS-0002-00
Tree strap, big mounting
base



Ordering Code:
AUN-CAB-0012-00
Cable H05RR-F 5x1, L=
2000mm, with UniBlock
anti-humidity kit,
pre-assembly from factory



Ordering Code:
ALUMINUM-POLE-FOR-FIN
Please contact Sales
Representative

*Due to the constancy of product development,
we reserve the right to alter all specification
without prior notice.

Unilamp Co., Ltd.
461 Ramintra Road, Kannayao, Bangkok 10230 Thailand
Tel : +66[0]2 943 2420-1, +66[0]2 946 4170-1
Fax : +66[0]2 943 2419
online@unilamp.co.th
www.unilamp.co.th

FIN

FIN LED

FLOOD LIGHT

 **Unilamp**

LAST UPDATE: 18-03-2026



Ordering Code:
STEEL-POLE-FOR-FIN
Please contact Sales
Representative

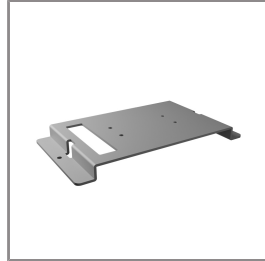

Ordering Code:
AUN-BRK-0015-XX
Mounting bracket,
pre-assembly from factory

*Due to the constancy of product development,
we reserve the right to alter all specification
without prior notice.

Unilamp Co., Ltd.
461 Ramintra Road, Kannayao, Bangkok 10230 Thailand
Tel : +66[0]2 943 2420-1, +66[0]2 946 4170-1
Fax : +66[0]2 943 2419
online@unilamp.co.th
www.unilamp.co.th