

REGOR

REGOR 200 FLOOD LIGHT



LAST UPDATE: 21-04-2026



REGOR is robust designed high performing flood light suitable for a wide range of applications. Equipped with a pre-wired cable of 1500mm length for rapid and cost-saving installation. The internal vent prevents moisture buildup and extends the useful life time and reliability. The integrated scale allows easy and reliable aiming. With a range of symmetric and asymmetric beams REGOR is a great choice for car parks, façade lighting and general large scale outdoor lighting applications. With a temperature range from -30°C to 50°C, IP66 water ingress protection and light weight construction REGOR ticks many boxes in everyday lighting specifications.

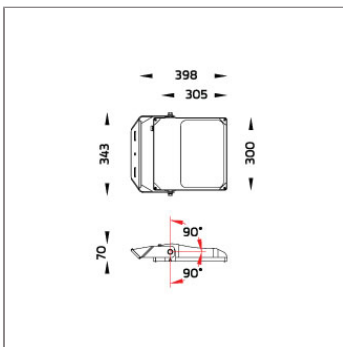

Technical Data



Ordering Code :	2203-D-3-007-A1
Lamp :	LED
Beam :	53°
CCT :	5000 K
CRI :	CRI >70
SDCM :	SDCM = 5
Luminaire Lumen :	29980 lm
Luminaire Wattage :	190.0 W
Efficacy :	157 lm/W
Ambient Temperature :	50°C
Lumen Maintenance	L80 >60,000 h (@25°C)
Controller :	On-Off
Input Voltage :	220-240Vac 50/60Hz
Net Weight :	5.30 kg.

Ordering code guide

XXXX-X-X-XXX-XX
A B C D E

- A Product Code
- B Reflector
- C Electrical Component
- D Lamp
- E Color



Icon definition

*Due to the constancy of product development, we reserve the right to alter all specification without prior notice.

Unilamp Co., Ltd.
461 Ramintra Road, Kannayao, Bangkok 10230 Thailand
Tel : +66(0)2 943 2420-1, +66(0)2 946 4170-1
Fax : +66(0)2 943 2419
online@unilamp.co.th
www.unilamp.co.th

Specification

IEC Standard	IEC 60598-1 General Requirement IEC 60598-2-1 Fixed Luminaires
Protection	IP66 Class I
IK Rating	Protection against mechanical impact IK08
Luminaires Body Housing	High-pressure die cast aluminum alloy body and components.
Coating Process	Luminaire top coated with UV stabilized polyester powder and cured in digital temperature controlled chamber at 200°C.
Diffuser	Impact resistant safety tempered glass cover. Able to withstand the temperature up to 250°C.
Lens	Molded PMMA lens from renowned manufacturers in various light distribution patterns.
Adjustable Optic	Adjustable aiming unit through graduated scale.
Gasket	Post-cured treated silicone gasket. Temperature and weather resistant. Working temperature -40°C to +200°C.
External Screws	External screws are in stainless steel with protection grease.
Led	High efficiency LED module utilized chips from world renowned manufacturer. Assembled on MCPCB and mounted on to heat conductive material.
Driver	High quality constant current LED driver. Conform to safety standard and electromagnetic compatibility standard.
Enhanced Protection	Pressure equalization element ensuring optimal performance in varying conditions.
Internal Wire	Tinned copper conductor with silicone insulated internal wire. IMQ approved. Working temperature -40°C to +180°C.
Pre-Wire Cable	Pre-wired with 1500mm long 3x1 sqmm cable.
Caution	Installation work has to be carried on according to the enclosed installation manual.
Color	 Black A1

Light Distribution

