

SPACE

MINI SPACE PROJECTOR



LAST UPDATE: 03-03-2025



Space is a range of next generation flood lights for demanding outdoor lighting tasks. Six different tailored made light engines cover a wide range of lighting applications. High efficacy 3SDCM COBs offer highest lumen output. The high power LED options for SPACE gives lighting designers a wide choice of carefully calculated light distributions, including an ultra-narrow beam down to 8°. The SPACE RGBW version with optics-based color mixing is the ideal solution for impactful highlighting of outdoor spaces. SPACE cans also be customized to tunable white solution which allows tasteful illumination of architectural structures in different color temperatures. Regardless of LED option, a glare shield cap, snoot and luminaire integrated honeycombs are available as standard accessory. Different mounting solutions such as a pole clamp or pole arm let SPACE to be installed in numerous applications. SPACE can be equipped with a built-in photocell, DALI2 control system or state of the art wireless control utilizing CASAMBI. Minimal amount of tools required for installation and the prewired electrical connection simplifies the installation process.



Technical Data



Ordering Code :	2040-A-5-388-XX
Lamp :	LED
Beam :	11°
CCT :	3000 K
CRI :	CRI >80
SDCM :	SDCM = 3
Lamp Lumen :	3120 lm
Luminaire Lumen :	2500 lm
Lamp Wattage :	26 W
Luminaire Wattage :	27 W
Efficacy :	92 lm/W
Ambient Temperature :	50°C
Lumen Maintenance	L80B10 >108,000 h
Controller :	DALI
Input Voltage :	220-240Vac 50/60Hz
Net Weight :	4.40 kg.

Ordering code guide

XXXX-X-X-XXX-XX
A B C D E

- A Product Code
- B Reflector
- C Electrical Component
- D Lamp
- E Color



Icon definition

*Due to the constancy of product development, we reserve the right to alter all specification without prior notice.

Unilamp Co., Ltd.
461 Ramintra Road, Kannayao, Bangkok 10230 Thailand
Tel : +66(0)2 943 2420-1, +66(0)2 946 4170-1
Fax : +66(0)2 943 2419
online@unilamp.co.th
www.unilamp.co.th

SPACE

MINI SPACE PROJECTOR



LAST UPDATE: 03-03-2025

Specification

IEC Standard	IEC 60598-1 General Requirement IEC 60598-2-1 Fixed Luminaires										
Protection	IP66 Class I										
IK Rating	Protection against mechanical impact IK10 on body and IK09 on optical part.										
Luminaires Body Housing	High-pressure die cast aluminum alloy body and components.										
Coating Process	Nano Ceramic surface conversion, resistant to corrosive environment. Luminaire primarily coated with epoxy resin and top coated with UV stabilized polyester powder and cured in digital temperature controlled chamber at 200°C.										
Diffuser	Impact resistant safety tempered glass cover. Able to withstand the temperature up to 250°C.										
Lens	Molded PC lens from renowned manufacturers in various light distribution patterns.										
Adjustable Optic	Adjustable aiming unit through graduated scale.										
Gasket	Post-cured treated silicone gasket. Temperature and weather resistant. Working temperature -40°C to +200°C.										
External Screws	External screws are in stainless steel with protection grease.										
Cable Entry	Cable entry protected by M20 cable gland. To be used with H05RN-F/ H07RN-F cable with 7-13mm. diameter.										
Led	High efficiency LED module utilized chips from world renowned manufacturer. Assembled on MCPCB and mounted on to heat conductive material.										
Driver	High quality DALI Driver in constant current. Conform to applicable safety standards and electromagnetic compatibility.										
Enhanced Protection	The luminaire is equipped with a 10kV surge protection device, the function of the protector is indicated by a LED, performance in compliance with IEC61643-11.										
Internal Wire	Tinned copper conductor with silicone insulated internal wire. IMQ approved. Working temperature -40°C to +180°C.										
Terminal Block	Terminal block in GFR PA6.6 for cable with cross section up to 2.5 sqmm. VDE approved. Class1 luminaire provided with the earth connection.										
Pre-Wire Cable	Pre-wired with 5-core cable for power (3x1 sqmm.) and dimming signal (2x1 sqmm.). Equipped with anti-humidity kit.										
Caution	Installation work has to be carried on according to the enclosed installation manual.										
Color	<table><tr><td></td><td>Black O1</td></tr><tr><td></td><td>Graphite O2</td></tr><tr><td></td><td>Dark Grey O3</td></tr><tr><td></td><td>Aluminum Silver O4</td></tr><tr><td></td><td>White O6</td></tr></table>		Black O1		Graphite O2		Dark Grey O3		Aluminum Silver O4		White O6
	Black O1										
	Graphite O2										
	Dark Grey O3										
	Aluminum Silver O4										
	White O6										

Light Distribution

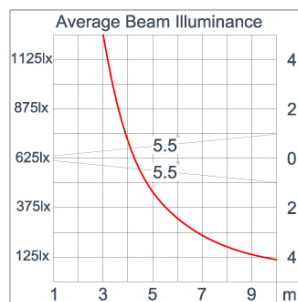
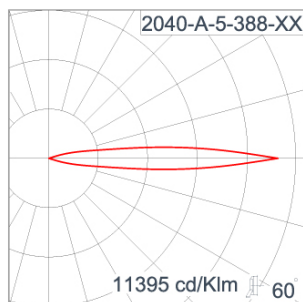

*Due to the constancy of product development,
we reserve the right to alter all specification
without prior notice.

Unilamp Co., Ltd.
461 Ramintra Road, Kannayao, Bangkok 10230 Thailand
Tel : +66(0)2 943 2420-1, +66(0)2 946 4170-1
Fax : +66(0)2 943 2419
online@unilamp.co.th
www.unilamp.co.th

SPACE

MINI SPACE PROJECTOR



LAST UPDATE: 03-03-2025

Accessories



Ordering Code:
AUN-CON-0011-00
IP68 connection device,
cable diameter 7.1-13mm,
1-10V or DALI



Ordering Code:
AUN-CON-0012-00
IP68 connection device 5
pole, cable diameter
7.1-13mm, with distribution
block, 1-10V or DALI



Ordering Code:
AUN-CON-0014-00
IP68 connection device,
cable diameter 8-12.5mm,
1-10V or DALI



Ordering Code:
AUN-CLP-0001-XX
Pole clamp, pole diameter
114mm



Ordering Code:
AUN-ACB-0009-00
Anchor bolt kit, pole
diameter 114 and 114/140,
galvanized steel pole



Ordering Code:
AUN-ACB-0008-00
Anchor bolt kit, pole
diameter 102mm and
151x102mm, galvanized
steel pole



Ordering Code:
AUN-ACB-0005-00
Anchor bolt kit, aluminum
pole



Ordering Code:
AUN-GHS-0033-XX
Glare shield cap



Ordering Code:
AUN-GSH-0025-XX
Snoot



Ordering Code:
AUN-POL-0030-XX
Cylindrical aluminum pole,
diameter 140mm, H=
410mm, use with projector



Ordering Code:
AUN-GSH-0028-00
Honeycomb louver, LED,
pre-assembly from factory



Ordering Code:
AUN-MOT-0001-XX
Pole mount adaptor, spigot
diameter 76mm for Mini
SPACE

*Due to the constancy of product development,
we reserve the right to alter all specification
without prior notice.

Unilamp Co., Ltd.
461 Ramintra Road, Kannayao, Bangkok 10230 Thailand
Tel : +66[0]2 943 2420-1, +66[0]2 946 4170-1
Fax : +66[0]2 943 2419
online@unilamp.co.th
www.unilamp.co.th

SPACE

MINI SPACE PROJECTOR



LAST UPDATE: 03-03-2025



Ordering Code:
AUN-MOT-0002-XX
Wall or pole mounting arm,
pole diameter 114mm for
Mini SPACE



Ordering Code:
AUN-MOT-0003-XX
Mounting base, rotateable,
1-10V or DALI for Mini
SPACE



Ordering Code:
AUN-MOT-0004-XX
Wall or pole mounting arm,
pole diameter 114mm,
double sided for Mini
SPACE



Ordering Code:
ALUMINUM-POLE-MINI-SPACE
Please contact Sales
Representative



Ordering Code:
STEEL-POLE-MINI-SPACE
Please contact Sales
Representative

*Due to the constancy of product development,
we reserve the right to alter all specification
without prior notice.

Unilamp Co., Ltd.
461 Ramintra Road, Kannayao, Bangkok 10230 Thailand
Tel : +66[0]2 943 2420-1, +66[0]2 946 4170-1
Fax : +66[0]2 943 2419
online@unilamp.co.th
www.unilamp.co.th