

# CANNON

## CANNON 360

### SPOTLIGHT



LAST UPDATE: 09-04-2026



By its very name Cannon has a robust construction and is suitable in applications that require high lighting levels from medium to long distance. A wide range of mounting accessories including ground mounting base, pole top mounting adaptor, wall/pole mounting arm and pole clamp are available. This luminaire family utilizes a high power COB LED with CRI 80+ in three steps SDCM. Version with HID light source is also available. CANNON is available in two sizes with mid-narrow, mid-wide and very wide beam angle in 2700K, 3000K and 4000K. The top performance reflectors used in this power projector are designed by high-end lighting engineering software. The integrated aiming scale allows the lighting designers to have confidence that the light will be distributed exactly on the desired surface. CANNON is suitable to light up medium-sized to large-sized objects or areas such as billboards, building facades, public parks, pedestrian, statues and public landmarks.

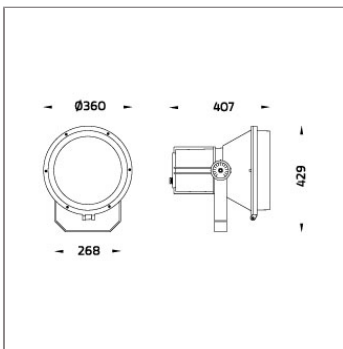

### Technical Data



Ordering Code :	2021-7-4-902-XX
Lamp :	LED
Beam :	60°
CCT :	3000 K
CRI :	CRI >80
SDCM :	SDCM = 3
Lamp Lumen :	13200 lm
Luminaire Lumen :	10280 lm
Lamp Wattage :	92 W
Luminaire Wattage :	96 W
Efficacy :	106 lm/W
Ambient Temperature :	40°C
Lumen Maintenance	L70B10 >90,000 h
Controller :	DIM 1-10V
Input Voltage :	220-240Vac 50/60Hz
Net Weight :	11.50 kg.

#### Ordering code guide

XXXX-X-X-XXX-XX

A B C D E

- A Product Code
- B Reflector
- C Electrical Component
- D Lamp
- E Color



Icon definition

\*Due to the constancy of product development, we reserve the right to alter all specification without prior notice.

Unilamp Co., Ltd.  
461 Ramintra Road, Kannayao, Bangkok 10230 Thailand  
Tel : +66(0)2 943 2420-1, +66(0)2 946 4170-1  
Fax : +66(0)2 943 2419  
online@unilamp.co.th  
www.unilamp.co.th

### Specification

IEC Standard	IEC 60598-1 General Requirement IEC 60598-2-1 Fixed Luminaires
Protection	IP66 Class I
IK Rating	Protection against mechanical impact IK08 on body and IK07 optical part.
Luminaires Body Housing	High-pressure die cast aluminum alloy body and components.
Coating Process	Nano Ceramic surface conversion, resistant to corrosive environment. Luminaire primarily coated with epoxy resin and top coated with UV stabilized polyester powder and cured in digital temperature controlled chamber at 200°C.
Diffuser	Impact resistant safety tempered glass cover. Able to withstand the temperature up to 250°C.
Reflector	High performance anodized spun aluminum reflector.
Adjustable Optic	Adjustable aiming unit through graduated scale.
Gasket	Post-cured treated silicone gasket. Temperature and weather resistant. Working temperature -40°C to +200°C.
External Screws	External screws are in stainless steel with protection grease.
Cable Entry	Cable entry protected by M20 cable gland. To be used with H05RN-F/ H07RN-F cable with 7-13mm. diameter.
Led	High efficiency LED module in COB technology. Assembled on MCPCB and mounted on to heat conductive material.
Driver	High quality Dimmable Driver [1-10V] in constant current. Conform to applicable safety standards and electromagnetic compatibility.
Enhanced Protection	The luminaire is equipped with a 10kV surge protection device, the function of the protector is indicated by a LED, performance in compliance with IEC61643-11
Internal Wire	Tinned copper conductor with silicone insulated internal wire. IMQ approved. Working temperature -40°C to +180°C.
Terminal Block	Terminal block in GFR PA6.6 for cable with cross section up to 2.5 sqmm. VDE approved. Class1 luminaire provided with the earth connection.
Pre-Wire Cable	Pre-wired with 5-core cable for power (3x1 sqmm.) and dimming signal (2x0.35 sqmm.).
Caution	Installation work has to be carried on according to the enclosed installation manual.
Color	 <ul style="list-style-type: none"> <li>Black O1</li> <li>Graphite O2</li> <li>Dark Grey O3</li> <li>Aluminum Silver O4</li> <li>White O6</li> </ul>

### Light Distribution

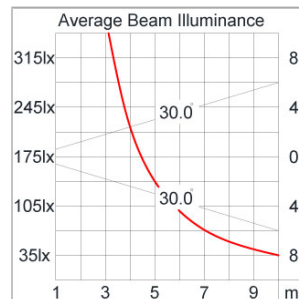
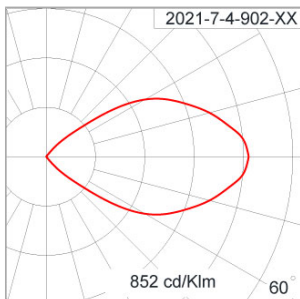

# CANNON

CANNON 360

SPOTLIGHT



LAST UPDATE: 09-04-2026

## Bug Report

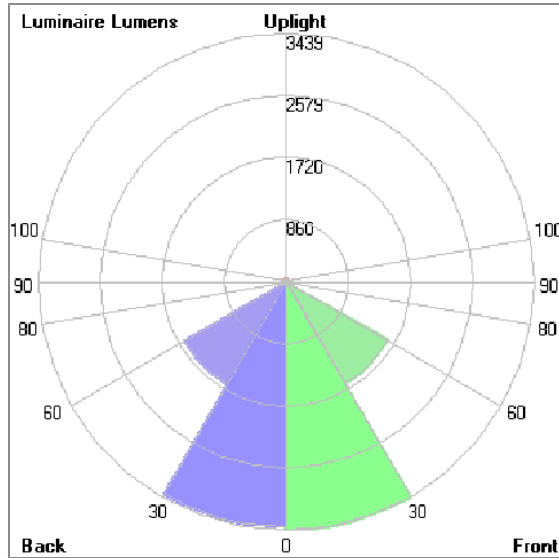

### Lum. Classification System [LCS]

LCS	Zone	%Lumens	%Lamp	%Lum
FL	[0-30]	3439.3	26.1	33.5
FM	[30-60]	1622.2	12.3	15.8
FH	[60-80]	72.7	0.6	0.7
FVH	[80-90]	2.4	0.0	0.0
BL	[0-30]	3391.8	25.7	33.0
BM	[30-60]	1633.1	12.4	15.9
BH	[60-80]	76.9	0.6	0.7
BVH	[80-90]	2.4	0.0	0.0
UL	[90-100]	0.0	0.0	0.0
UH	[100-180]	39.1	0.3	0.4
Total		10279.9	78.0	100.0
BUG Rating		B4-U2-G0		

\*Due to the constancy of product development, we reserve the right to alter all specification without prior notice.

Unilamp Co., Ltd.  
461 Ramintra Road, Kannayao, Bangkok 10230 Thailand  
Tel : +66[0]2 943 2420-1, +66[0]2 946 4170-1  
Fax : +66[0]2 943 2419  
online@unilamp.co.th  
www.unilamp.co.th

# CANNON

## CANNON 360

### SPOTLIGHT



LAST UPDATE: 09-04-2026

#### Accessories



Ordering Code:  
AUN-CON-0011-00  
IP68 connection device,  
cable diameter 7.1-13mm,  
1-10V or DALI



Ordering Code:  
AUN-CON-0012-00  
IP68 connection device 5  
pole, cable diameter  
7.1-13mm, with distribution  
block, 1-10V or DALI



Ordering Code:  
AUN-CON-0014-00  
IP68 connection device,  
cable diameter 8-12.5mm,  
1-10V or DALI



Ordering Code:  
STEEL-POLE-FOR-CANNON-360  
Please contact Sales  
Representative

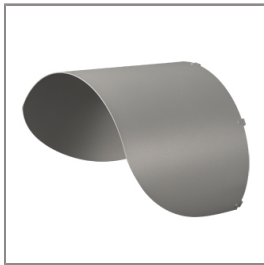

Ordering Code:  
AUN-GHS-0009-XX  
Glare shield cap

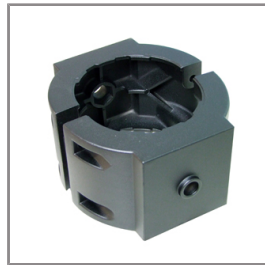

Ordering Code:  
AUN-CLP-0001-XX  
Pole clamp, pole diameter  
114mm



Ordering Code:  
AUN-ACB-0009-00  
Anchor bolt kit, pole  
diameter 114 and 114/140,  
galvanized steel pole



Ordering Code:  
AUN-ACB-0008-00  
Anchor bolt kit, pole  
diameter 102mm and  
151x102mm, galvanized  
steel pole



Ordering Code:  
AUN-ACB-0005-00  
Anchor bolt kit, aluminum  
pole



Ordering Code:  
AUN-MOT-0001-XX  
Pole mount adaptor, spigot  
diameter 76mm for  
CANNON

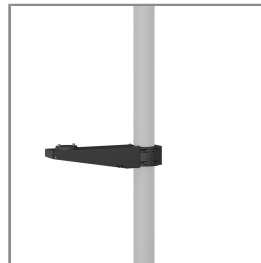

Ordering Code:  
AUN-MOT-0066-XX  
Wall or pole mounting arm,  
pole diameter 114mm single  
side



Ordering Code:  
AUN-MOT-0003-XX  
Mounting base, rotateable,  
1-10V or DALI for CANNON

\*Due to the constancy of product development,  
we reserve the right to alter all specification  
without prior notice.

Unilamp Co., Ltd.  
461 Ramintra Road, Kannayao, Bangkok 10230 Thailand  
Tel : +66(0)2 943 2420-1, +66(0)2 946 4170-1  
Fax : +66(0)2 943 2419  
online@unilamp.co.th  
www.unilamp.co.th

# CANNON

CANNON 360

SPOTLIGHT

 **Unilamp**

LAST UPDATE: 09-04-2026

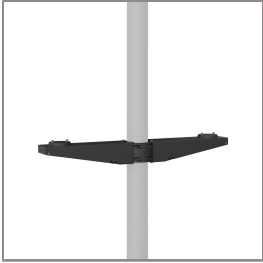

Ordering Code:  
AUN-MOT-0067-XX  
Wall or pole mounting arm,  
pole diameter 114mm,  
double



Ordering Code:  
ALUMINUM-POLE-FOR-CANNON-360  
Please contact Sales  
Representative

\*Due to the constancy of product development,  
we reserve the right to alter all specification  
without prior notice.

Unilamp Co., Ltd.  
461 Ramintra Road, Kannayao, Bangkok 10230 Thailand  
Tel : +66[0]2 943 2420-1, +66[0]2 946 4170-1  
Fax : +66[0]2 943 2419  
online@unilamp.co.th  
www.unilamp.co.th