

CANNON

CANNON 280

POWER PROJECTORS



LAST UPDATE: 03-05-2024



By its very name Cannon has a robust construction and is suitable in applications that require high lighting levels from medium to long distance. A wide range of mounting accessories including ground mounting base, pole top mounting adaptor, wall/pole mounting arm and pole clamp are available. This luminaire family utilizes a high power COB LED with CRI 80+ in three steps SDCM. Version with HID light source is also available. CANNON is available in two sizes with mid-narrow, mid-wide and very wide beam angle in 2700K, 3000K and 4000K. The top performance reflectors used in this power projector are designed by high-end lighting engineering software. The integrated aiming scale allows the lighting designers to have confidence that the light will be distributed exactly on the desired surface. CANNON is suitable to light up medium-sized to large-sized objects or areas such as billboards, building facades, public parks, pedestrian, statues and public landmarks.

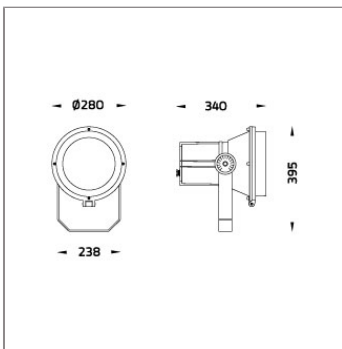

Technical Data



Ordering Code :	2020-7-3-711-XX
Lamp :	HIE-CE
Socket :	E27
Beam :	70°
CCT :	3000-4200 K
Lamp Lumen :	5900 lm
Luminaire Lumen :	5900 lm
Lamp Wattage :	70 W
Luminaire Wattage :	70 W
Ambient Temperature :	25°C
Controller :	On-Off
Input Voltage :	230Vac 50Hz
Net Weight :	7.40 kg.

Ordering code guide

XXXX-X-X-XXX-XX

A B C D E

- A Product Code
- B Reflector
- C Electrical Component
- D Lamp
- E Color





















Icon definition

*Due to the constancy of product development, we reserve the right to alter all specification without prior notice.

Unilamp Co., Ltd.
461 Ramintra Road, Kannayao, Bangkok 10230 Thailand
Tel : +66[0]2 943 2420-1, +66[0]2 946 4170-1
Fax : +66[0]2 943 2419
online@unilamp.co.th
www.unilamp.co.th

Specification

IEC Standard	IEC 60598-1 General Requirement IEC 60598-2-1 Fixed Luminaires												
Protection	IP66 Class I												
IK Rating	Protection against mechanical impact IK09 on body and optical part.												
Luminaires Body Housing	High-pressure die cast aluminum alloy body and components.												
Coating Process	Nano Ceramic surface conversion, resistant to corrosive environment. Luminaire primarily coated with epoxy resin and top coated with UV stabilized polyester powder and cured in digital temperature controlled chamber at 200°C.												
Diffuser	Impact resistant safety tempered glass cover. Able to withstand the temperature up to 250°C.												
Reflector	High performance anodized spun aluminum reflector.												
Adjustable Optic	Adjustable aiming unit through graduated scale.												
Gasket	Post-cured treated silicone gasket. Temperature and weather resistant. Working temperature -40°C to +200°C.												
External Screws	External screws are in stainless steel with protection grease.												
Cable Entry	Cable entry protected by M20 cable gland. To be used with H05RN-F/ H07RN-F cable with 7-13mm. diameter.												
Lamp Holder	E27 lampholder in ceramic body. VDE/ ENEC approved.												
Ballast	Vacuum impregnated magnetic ballast for HID lamp. ENEC approved.												
Capacitor	Aluminum case capacitor with over pressure safety device. ENEC approved.												
Ignitor	Electronic ignitor with automatic switch-off function. ENEC approved.												
Internal Wire	Tinned copper conductor with silicone insulated internal wire. IMQ approved. Working temperature -40°C to +180°C. HID control gear wired with double insulated silicone cable and compatible to be operated under ignition voltage up to 5KV.												
Terminal Block	Terminal block in GFR PA6.6 for cable with cross section up to 2.5 sqmm. VDE approved. Class1 luminaire provided with the earth connection.												
Caution	Installation work has to be carried on according to the enclosed installation manual.												
Color	<table border="0"> <tr> <td></td> <td>Black O1</td> </tr> <tr> <td></td> <td>Graphite O2</td> </tr> <tr> <td></td> <td>Dark Grey O3</td> </tr> <tr> <td></td> <td>Aluminum Silver O4</td> </tr> <tr> <td></td> <td>White O6</td> </tr> <tr> <td></td> <td>Wooden Brown O7</td> </tr> </table>		Black O1		Graphite O2		Dark Grey O3		Aluminum Silver O4		White O6		Wooden Brown O7
	Black O1												
	Graphite O2												
	Dark Grey O3												
	Aluminum Silver O4												
	White O6												
	Wooden Brown O7												

Light Distribution

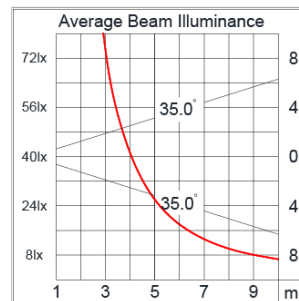
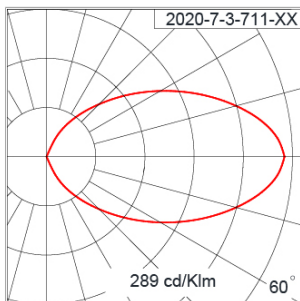

*Due to the constancy of product development, we reserve the right to alter all specification without prior notice.

CANNON

CANNON 280

POWER PROJECTORS



LAST UPDATE: 03-05-2024

Accessories



Ordering Code:
AUN-CON-0009-00
IP68 Water Tight
Connecting Device, 3 Pole,
Cable Diameter 5.0 -
9.5mm.



Ordering Code:
AUN-CON-0010-00
IP68 Water Tight
Connecting Device with
Distribution block, 3 pole, 1
input, 2 outputs, Cable
Diameter 5.0 - 9.5mm.



Ordering Code:
AUN-CON-0013-00
IP68 Water Tight
Connecting Device, 3 Pole,
Cable Diameter 7 - 11.5mm.



Ordering Code:
STEEL-POLE-FOR-CANNON-280
Please contact Sales
Representative

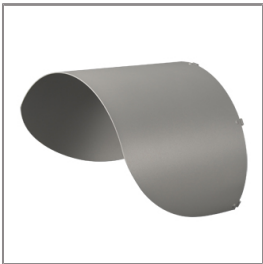

Ordering Code:
AUN-GHS-0008-XX
Glare Shield Cap



Ordering Code:
AUN-SOF-0001-00
Flat Beam Lens



Ordering Code:
AUN-CLP-0001-XX
Pole Clamp Diameter
114mm.

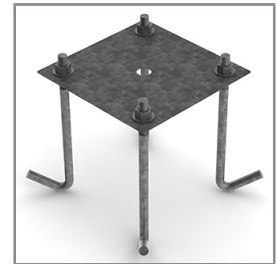

Ordering Code:
AUN-ACB-0009-00
Anchor Bolt Kit for
Galvanized Steel Pole. [for
pole Diameter 114mm. and
Diameter 114&140mm.]



Ordering Code:
AUN-ACB-0008-00
Anchor Bolt Kit for
Galvanized Steel Pole. [for
Diameter 102mm. and
151x102mm.]



Ordering Code:
AUN-ACB-0005-00
Anchor Bolt Kit for
Aluminium Pole



Ordering Code:
AUN-MOT-0001-XX
Pole Top Mount Adaptor
Spigot Size 76mm.



Ordering Code:
AUN-MOT-0002-XX
Wall or Pole Mounting Arm
Diameter 114mm.

*Due to the constancy of product development,
we reserve the right to alter all specification
without prior notice.

Unilamp Co., Ltd.
461 Ramintra Road, Kannayao, Bangkok 10230 Thailand
Tel : +66[0]2 943 2420-1, +66[0]2 946 4170-1
Fax : +66[0]2 943 2419
online@unilamp.co.th
www.unilamp.co.th

CANNON

CANNON 280

POWER PROJECTORS



LAST UPDATE: 03-05-2024



Ordering Code:
AUN-MOT-0003-XX
Mounting Base for dimming
interface [1-10V or Dali]



Ordering Code:
AUN-MOT-0004-XX
Wall or Pole Mounting
Double Arm Diameter
114mm.



Ordering Code:
ALUMINUM-POLE-FOR-CANNON-280
Please contact Sales
Representative

*Due to the constancy of product development,
we reserve the right to alter all specification
without prior notice.

Unilamp Co., Ltd.
461 Ramintra Road, Kannayao, Bangkok 10230 Thailand
Tel : +66(O)2 943 2420-1, +66(O)2 946 4170-1
Fax : +66(O)2 943 2419
online@unilamp.co.th
www.unilamp.co.th